

产品特点

- 超高纯度气体终端控制面板适用于所有气体输送系统
100TG: ≤30 slpm 连接1/4" VFS
200TG: ≤300 slpm 连接3/8" VFS
300TG: ≤600slpm 连接1/2" VFS
- 控制精度高
- VFS面密封连接
- 手动或气动隔膜阀选择
- 100%氦泄漏测试

技术参数

进气压力 P1:	300 psig
出气压力 P2:	30/60/100/150 psig
隔膜阀材质	
母体:	316L
阀座:	PCTFE
膜片:	Elgiloy®
减压器材质	
母体:	316L / 316L 二次熔炼
阀座:	PCTFE
膜片:	Hastelloy® C276
泄漏率: (外部)	1×10^{-9} mbar l/s He
(内部)	1×10^{-8} mbar l/s He



产品尺寸 (mm)

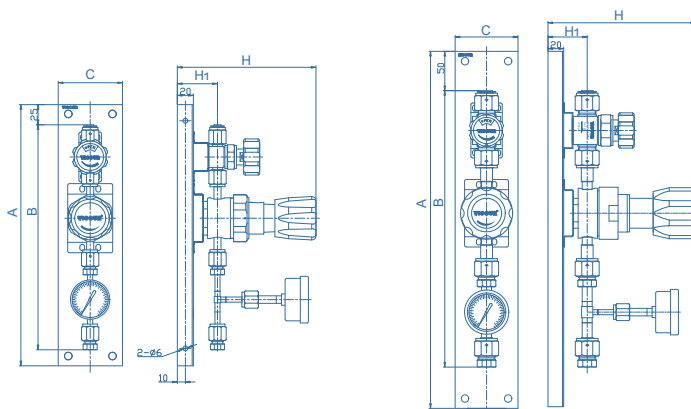

VUP-100TG (A 型)

VUP-200TG / VUP-300TG (A 型)

类型	面板厚度 mm	订购编号	尺寸, mm				
			A	B	C	H	H1
100TG	20	VUP-100TG-A	325	280	80	172.5	50
200TG	20	VUP-200TG-A	455	352.4	80	188	50
300TG	20	VUP-300TG-A	455	349.2	80	188	50



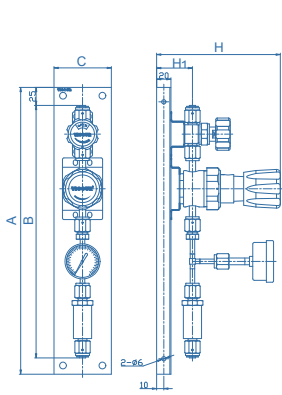

VUP-100TG (B型)

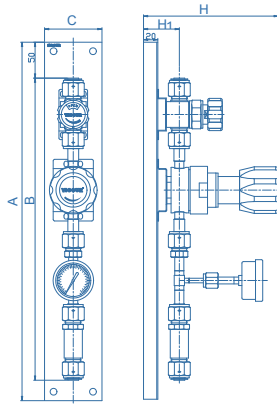

VUP-200TG / VUP-300TG (B型)

类型	面板厚度 mm	订购编号	尺寸, mm				
			A	B	C	H	H1
100TG	20	VUP-100TG-B	400	352.3	80	172.5	50
200TG	20	VUP-200TG-B	500	421.4	80	188	50
300TG	20	VUP-300TG-B	500	418.2	80	188	50

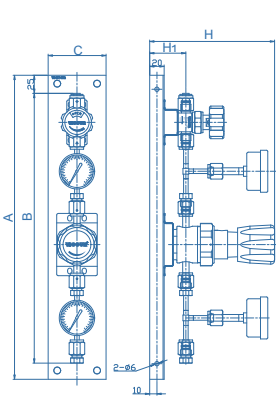

VUP-100TG (C型)

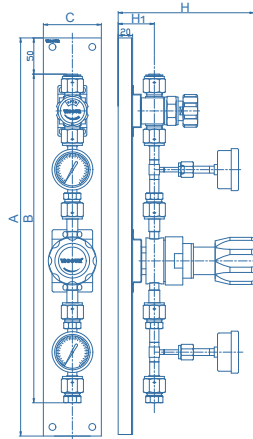

VUP-200TG / VUP-300TG (C型)

类型	面板厚度 mm	订购编号	尺寸, mm				
			A	B	C	H	H1
100TG	20	VUP-100TG-C	420	372.6	80	172.5	50
200TG	20	VUP-200TG-C	550	454.1	80	188	50
300TG	20	VUP-300TG-C	550	447.7	80	188	50

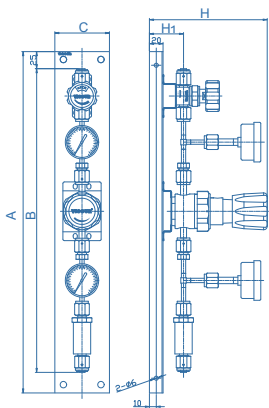

VUP-100TG (D型)

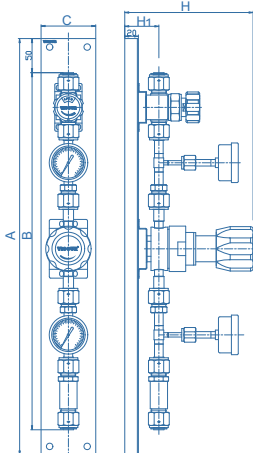

VUP-200TG / VUP-300TG (D型)

类型	面板厚度 mm	订购编号	尺寸, mm				
			A	B	C	H	H1
100TG	20	VUP-100TG-D	500	444.9	80	172.5	50
200TG	20	VUP-200TG-D	610	523.1	80	188	50
300TG	20	VUP-300TG-D	610	516.7	80	188	50



订购参数

VUP - 100TG - D - 20 - 10 - FV4 - P - P - FV4 - F - PC

