

### 产品特点

- 管路式减压器
- 母体和上盖黄铜电镀, 适用于6.0级非腐蚀性气体和混合气体
- 母体和上盖316L, 适用于腐蚀性气体
- 多种母体孔位设计, 适用于多种进出气结构
- 稳定的出气压力
- 手轮调节, 精确控制压力
- 一体式阀芯设计, 内置过滤网
- 适用于氧气



### 产品应用

- 组件试验
- 校准系统
- 实验室压力控制
- 高压取样系统
- 维护和测试设备

VSR-1EL



VSR-1ELP



安装面板  
型号: VSR-T-BPB

### 产品尺寸

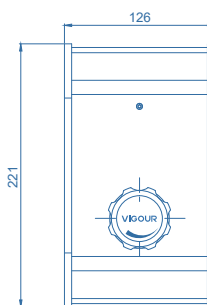
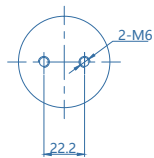
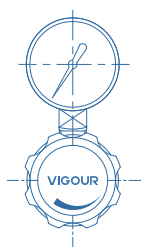
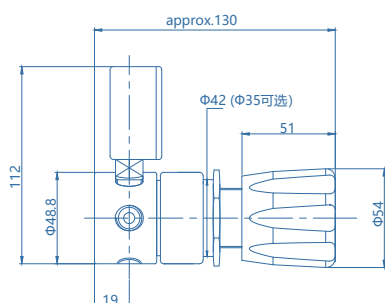

面板安装

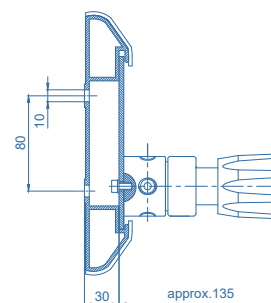

### 技术参数

类型:	单级式减压
进气压力 P1:	最大 100bar
出气压力 P2:	VAC/2/4/8/10/20 bar
材质	
减压器母体/安全阀:	详见订购参数
阀座:	PCTFE
膜片:	Hastelloy® C276
过滤网:	SS 316L
进/出气连接:	1/4" NPT(F)
温度适用:	-30°C to +74°C
泄漏率(外部):	1x10 <sup>-8</sup> mbar l/s He
(内部):	1x10 <sup>-6</sup> mbar l/s He
流量参数:	Cv=0.18
重量:	1.04kg

### 流量参数

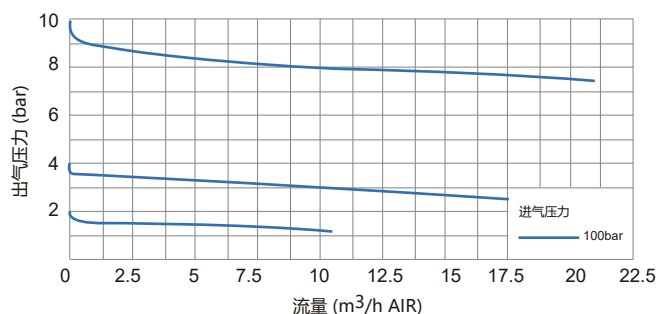

### 订购参数

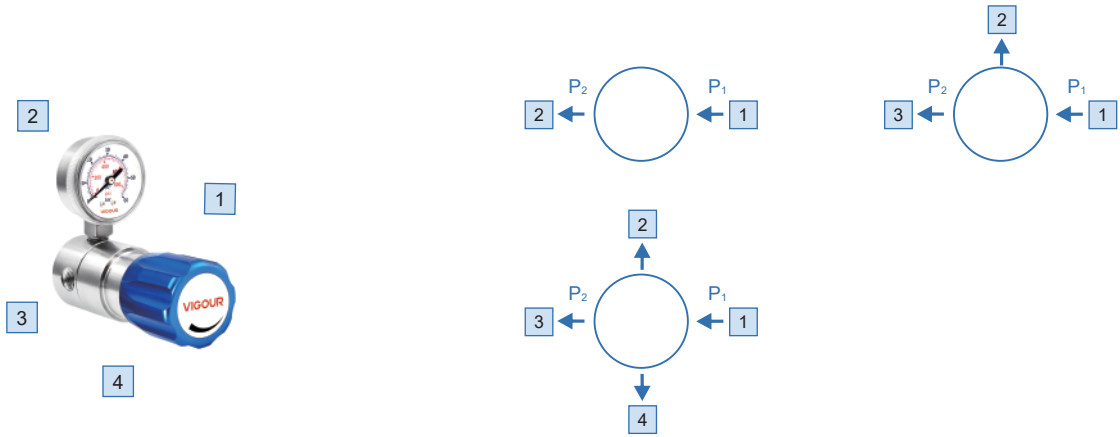

#### 进/出气连接

F4: 1/4" NPT(F)	02: 1/8" 卡套接头	8M: 8mm卡套接头	B: 堵头
M4: 1/4" NPT(M)	04: 1/4" 卡套接头	TW6M: 6mm焊接接管	
F6: 3/8" NPT(F)	06: 3/8" 卡套接头	TW8M: 8mm焊接接管	
M6: 3/8" NPT(M)	6M: 6mm卡套接头	P: 压力表(Psig/bar)	

\* 其他连接标准, 请咨询经销商.

#### 接口形式选择

VSR - 1EL - S - 100 - 20 - 1 - 2 - 3 - 4 - N2



### 订购举例

举例: VSR - 1EL - C - 100 - 20 - F4 - P - F4 - B - O<sub>2</sub>

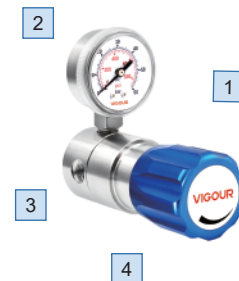

\* 混合气体, 订购时请注明钢瓶连接标准和螺纹规格.

